

IMPERO-DECO VE 813 S16 140

Design by: Studio Stile Masiero



Telaio in metallo cromato, pendagli in cristallo.

Chrome plated metal frame, crystal pendants.

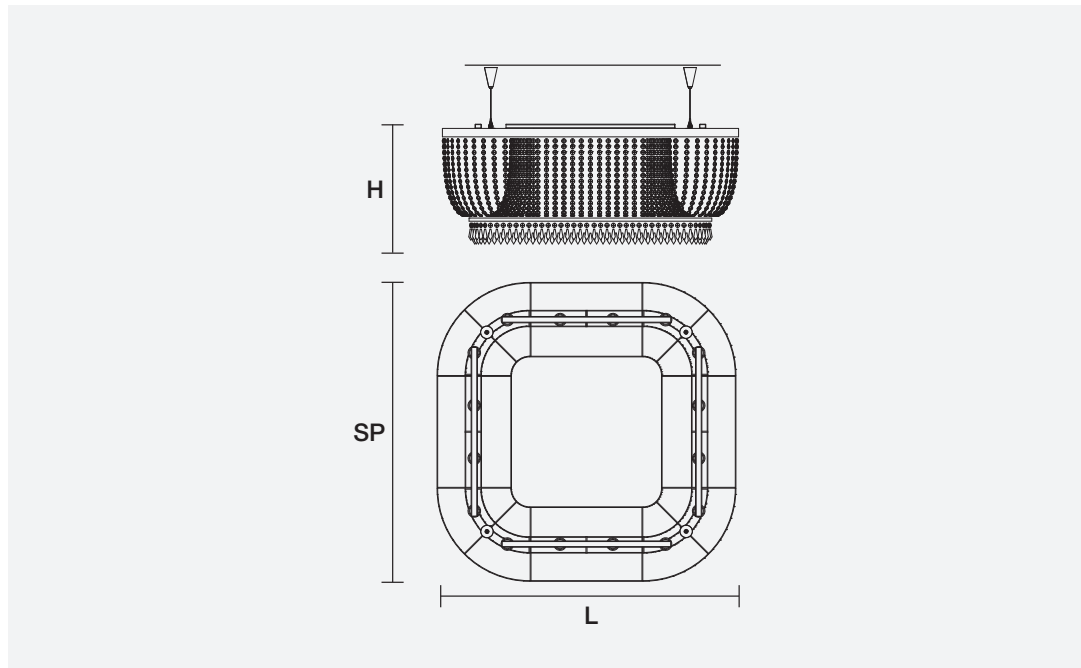

H 55 cm
21.65"

Ø 140 cm
55.11"

SP 140 cm
55.11"

Peso: 50 kg

 16 x E27 x 60W max
Incandescenza/Incandescent



MATERIALI MATERIALS

CUT CRYSTAL

Pendagli in cristallo trasparente molato.

Pendants in transparent cut crystal.

SWAROVSKI® ELEMENTS

Pendagli in cristallo trasparente SWAROVSKI® ELEMENTS.

Pendants in transparent SWAROVSKI® ELEMENTS crystal.

HALF CUT GLASS

Pendagli in vetro semi-molato.

Half cut glass pendants.